

Main features of the VD series battery solenoid valves are the extreme compactness of the product with the possibility to install them at any position of the machine, the high frequency and the speed of response. They are available in different functions: 2/2, 3/2, with or without manual drive screw.

Les principales caractéristiques des électrovannes en batterie de la série VD sont l'extrême compacité du produit avec la possibilité de montage en tout point de la machine, la haute fréquence et la rapidité de réponse. Disponible avec différentes fonctions : 2/2, 3/2, avec ou sans vis d'actionnement manuel.

Le caratteristiche principali delle elettrovalvole in batteria della serie VD sono l'estrema compattezza del prodotto con la possibilità di montaggio in qualsiasi punto della macchina, l'alta frequenza e la velocità di risposta. Disponibile in diverse funzioni: 2/2, 3/2, con o senza vite di azionamento manuale.

**TECHNICAL DATA / DONNÉES TECHNIQUES / DATI TECNICI**

Fluid / <b>Fluide</b> / <i>Fluido</i>	Lubricated or non lubricated air / <b>Air lubrifié ou non</b> / <i>Aria con o senza lubrificazione</i>
Type / <b>Type</b> / <i>Tipo</i>	3/2 - 2/2 NC Normally closed / <b>3/2 - 2/2 NF Normalement fermé</b> / <i>3/2 - 2/2 NC Normalmente chiuso</i>
Max operating pressure / <b>Pression max d'utilisation</b> / <i>Pressione massima di esercizio</i>	10 bar
Max working temperature / <b>Température max d'utilisation</b> / <i>Temperatura max di esercizio</i>	-10°C / + 50°C
Flow rate to 6 bar and Δp 1 bar / <b>Débit à 6 bar et Δp 1 bar</b> / <i>Portata a 6 bar e Δp 1 bar</i>	70 NI/min
Nominal orifice / <b>Diamètre nominal</b> / <i>Diametro nominale</i>	1.1mm
Tension tolerance / <b>Tolérance de tension</b> / <i>Tolleranza di tensione</i>	-10% - + 15%
Response time / <b>Temps de réponse</b> / <i>Tempo di risposta</i>	10ms
Duty cycle / <b>Temps d'enclenchement</b> / <i>Inserimento</i>	ED 100%
Rated power consumption / <b>Consommation</b> / <i>Consumo a regime</i>	DC: 3W - AC: 5VA
Coils tension / <b>Tension bobine</b> / <i>Tensione bobine</i>	24VDC - 24VAC - 110VAC - 220VAC 50/60Hz

**ORDERING CODE / CODIFICATION / CHIAVE DI CODIFICA**

V D 3 2 1 2 3 0 2

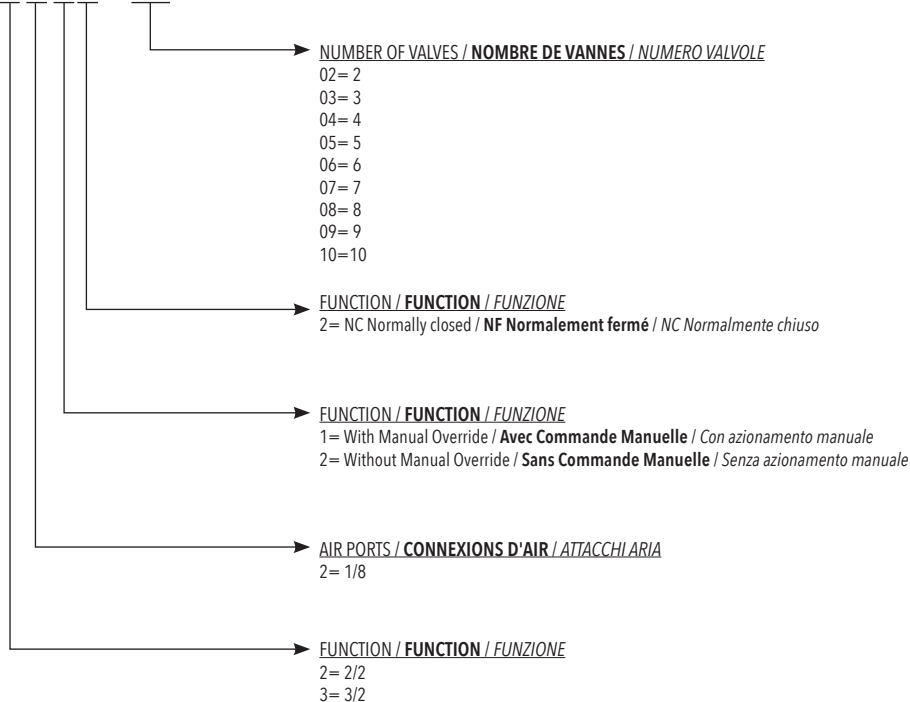

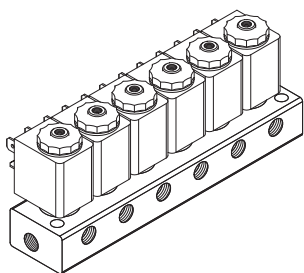
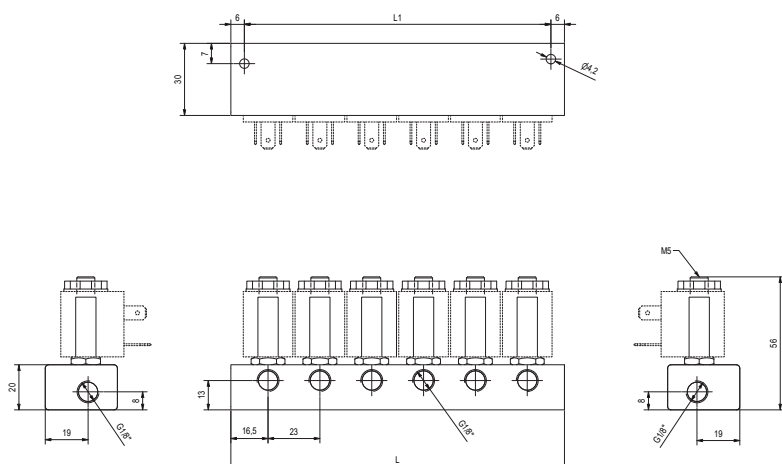

3/2 NC Normally closed WITHOUT MANUAL OVERRIDE  
**3/2 NF Normalement fermé SANS COMMANDE MANUELLE**  
 3/2 NC Normalmente chiuso SENZA AZIONAMENTO MANUALE

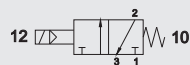

CODE	N.VALVES	L	L1
VD3222302	2	56	44
VD3222303	3	79	67
VD3222304	4	102	90
VD3222305	5	125	113
VD3222306	6	148	136
VD3222307	7	171	159
VD3222308	8	194	182
VD3222309	9	217	205
VD3222310	10	240	228

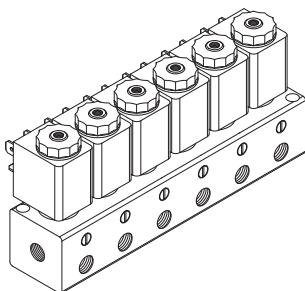
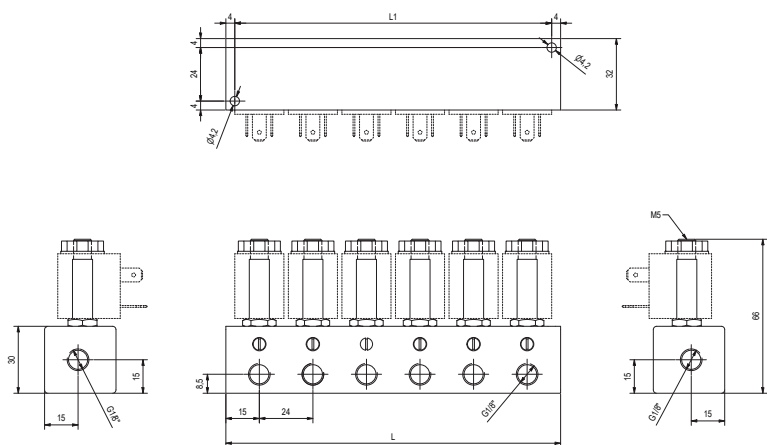

3/2 NC Normally closed WITH MANUAL OVERRIDE  
**3/2 NF Normalement fermé AVEC COMMANDE MANUELLE**  
 3/2 NC Normalmente chiuso CON AZIONAMENTO MANUALE

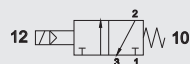

CODE	N.VALVES	L	L1
VD3212302	2	54	46
VD3212303	3	78	70
VD3212304	4	102	94
VD3212305	5	126	118
VD3212306	6	150	142

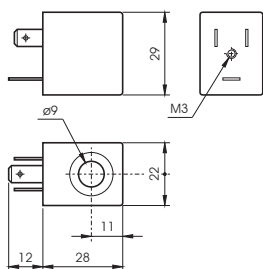

COILS  
**BOBINE**  
 BOBINE

CODE	POWER / ABSORPTION / ASSORBIMENTO		
	Tension Tensione	Rated Résistance a regime	Inrush De sortie di spunto
BO4011012	12 VDC	3W	
BO4011024	24 VDC	3W	
BO4012024	24 VAC	5VA	7,5VA
BO4012110	110 VAC	5VA	7,5VA
BO4012220	220 VAC	5VA	7,5VA

TECHNICAL SPECIFICATIONS  
**CARACTERISTIQUES TECHNIQUES**  
 CARATTERISTICHE TECNICHE

Tension tolerance / <b>Tolérance</b> / Tolleranza di tensione	+10%
Protection with connector / <b>Protection avec connecteur</b> / Protezione con connettore	IP65
Max working temperature / <b>Température max d'utilisation</b> / Temperatura max di esercizio	+ 50°C
Duty cycle / <b>Temps d'enclenchement</b> / Inserimento	ED 100%

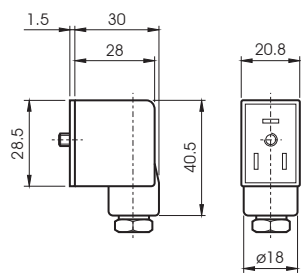
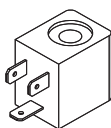

CONNECTORS  
**CONNECTEUR**  
 CONNETTORI

CODE	DES.
AR40696	STANDARD
VX0014	LED 24V
VX0015	LED 110V
VX0016	LED 220V
VX0017	LED+VDR 24V
VX0018	LED+VDR 110V
VX0019	LED+VDR 220V

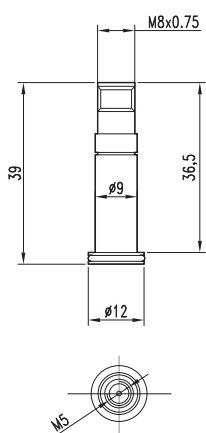
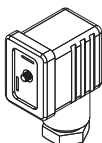

SOLENOID PILOT  
**ELECTROPILOTE**  
 ELETTROPILOTA

CODE	EP43603
------	---------

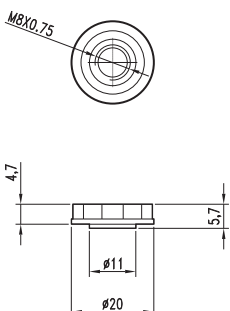
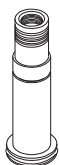

NUT  
**ECROU**  
 DADO

CODE	DA42937
------	---------

